

## TECHNOLOGY



### Data Pulse

Advanced control and power for precise dimming and efficient signal handling.



### Data Whisper

Automates address assignment for DMX lighting in the Data Pulse network, ensuring easy setup and system reliability.



### Color Shout

Enhances LED brightness and color saturation, efficiently managing power for fewer, high-quality luminaires.



### X Line

Efficiently distributes power and data in lighting systems, simplifying installation and enhancing energy efficiency.



### Split & Seal

Uses protective polymers to shield Filix products from water and moisture, boosting durability and resilience.



### Heat Sense

Automatically reduces LED power at high temperatures, ensuring longevity and safety in Filix products.

## RDD200



### ASHRAE/IEC 90.1 Compliant

Defines energy efficiency standards for building design, focusing on insulation, HVAC, and sustainable energy use.

### Qualicoat Seaside Class Powder Coat

Enhanced powder coating for aluminum, specifically formulated for superior durability and optimal performance in marine environments, lasting for over 10 years.



## RDD200

Specification Sheet



**UL STD 1598 Pending**  
**IP67**

### LUMINAIRE FEATURES

#### Design and Application

- Facade lighting
- Architectural lighting
- Landscape lighting
- Residential projects

#### Mechanical details

- IK10 crystal-clear tempered glass, 15mm (0.59") thick
- IP67, rated for temporary submersion (30min) in water up to 1m
- Die-Cast aluminium body
- AISI304 stainless steel flange in frosted finish
- Double surface protected body with anodised base layer and powder coat top layer in Qualicoat Seaside standard
- Drive-over rated for 5000 kg (11000 lbs)
- Supplied with IP68 connectors as a standard
- Recessed installation secured by A2 grade screws
- LED hight adjustment

#### Electrical details

- LED Lifetime TM-21 @ 105°  
CL80(24K)=145,000 hours
- Operating temperature -40°C (-40°F) to +50°C (122°F)
- LED CRI: >85
- Safety Class II
- On site LED module replacement
- On site engine replacement

#### Sustainability

- 91% Recyclable
- 95% Repairable

#### Controls

- DMX (Data Pulse)
- DALI
- 0-10V

#### Integrated Systems:

- Data Whisper
- Colour Shout
- X Line
- Split & Seal
- Heat Sense

#### Links and Downloads

- [Fixure installation manual](#)
- [Housing installation manual](#)
- [CAD file](#)
- [IES-LTD data](#)



## RDD200

### ORDERING INFORMATION

<b>MODEL</b>	
<b>RDD200</b>	
<b>INSTALLATION</b>	
<b>TM</b>	<ul style="list-style-type: none"><li>• TM - Trim</li></ul>
<b>POWER</b>	
<b>H</b>	<ul style="list-style-type: none"><li>• H - 25W - 2750lm</li><li>• H - 25W - TW (2200K-4000K)</li><li>• H - 25W - RGBW (W 3000K)</li><li>• H - 25W - RGBA (A Amber)</li></ul>
<b>COLOR TEMP.</b>	
<b>A</b>	<ul style="list-style-type: none"><li>• A - Amber</li></ul>
<b>27</b>	<ul style="list-style-type: none"><li>• 27 - 2700K</li></ul>
<b>30</b>	<ul style="list-style-type: none"><li>• 30 - 3000K</li></ul>
<b>40</b>	<ul style="list-style-type: none"><li>• 40 - 4000K</li></ul>
<b>TW</b>	<ul style="list-style-type: none"><li>• TW - Tunable white 2200K-4000K</li></ul>
<b>RGBW</b>	<ul style="list-style-type: none"><li>• RGBW (W 3000K)</li></ul>
<b>RGBA</b>	<ul style="list-style-type: none"><li>• RGBA (A Amber)</li></ul>
<b>OPTICS</b>	
<b>NS</b>	<ul style="list-style-type: none"><li>• NS - Narrow Spot 8°x8°</li></ul>
<b>MS</b>	<ul style="list-style-type: none"><li>• MS - Medium Spot 15°x15°</li></ul>
<b>NF</b>	<ul style="list-style-type: none"><li>• NF - Narrow Flood 30°x30°</li></ul>
<b>MF</b>	<ul style="list-style-type: none"><li>• MF - Medium Flood 40°x40°</li></ul>
<b>W</b>	<ul style="list-style-type: none"><li>• W - Wide 60°x60°</li></ul>
<b>SY</b>	<ul style="list-style-type: none"><li>• SY - Spot Asymmetric 10°x20°</li></ul>
<b>NY</b>	<ul style="list-style-type: none"><li>• NY - Narrow Asymmetric 10°x40°</li></ul>
<b>MY</b>	<ul style="list-style-type: none"><li>• MY - Medium Asymmetric 10°x60°</li></ul>
<b>VOLTAGE</b>	
<b>110</b>	<ul style="list-style-type: none"><li>• 110 - 110-277VAC, 60Hz</li></ul>
<b>230</b>	<ul style="list-style-type: none"><li>• 230 - 220-240VAC, 50Hz</li></ul>
<b>CONTROL</b>	
<b>0</b>	<ul style="list-style-type: none"><li>• 0 - ON-OFF operation</li></ul>
<b>X</b>	<ul style="list-style-type: none"><li>• X - DMX operation</li></ul>
<b>D</b>	<ul style="list-style-type: none"><li>• D - DALI operation</li></ul>
<b>V</b>	<ul style="list-style-type: none"><li>• V - 0-10V operation</li></ul>
<b>FINISH</b>	
<b>P</b>	<ul style="list-style-type: none"><li>• P - Polished trim finish</li></ul>
<b>F</b>	<ul style="list-style-type: none"><li>• F - Frosted trim finish</li></ul>
<b>INTERNAL GLARE CONTROL</b>	
<b>0</b>	<ul style="list-style-type: none"><li>• 0 - No internal glare control</li></ul>
<b>1</b>	<ul style="list-style-type: none"><li>• 1 - Microlouvre</li></ul>
<b>2</b>	<ul style="list-style-type: none"><li>• 2 - Hex louvre</li></ul>
<b>3</b>	<ul style="list-style-type: none"><li>• 3 - Discrete sight</li></ul>
<b>GLASS TYPE</b>	
<b>0</b>	<ul style="list-style-type: none"><li>• 0 - Clear glass</li></ul>
<b>1</b>	<ul style="list-style-type: none"><li>• 1 - Half moon</li></ul>
<b>2</b>	<ul style="list-style-type: none"><li>• 2 - Anti-slip glass</li></ul>



## RDD200

### MANDATORY ACCESSORIES

#### Feed Cables - art. FCUTL4P

##### LENGTHS

- |    |                       |
|----|-----------------------|
| 1  | • 1 - 1m feed cable   |
| 3  | • 3 - 3m feed cable   |
| 6  | • 6 - 6m feed cable   |
| 9  | • 9 - 9m feed cable   |
| 20 | • 20 - 20m feed cable |

#### End caps

##### END CAPS

- |        |                               |
|--------|-------------------------------|
| 104964 | • 104964 - End cap            |
| CD     | • CD - DMX terminator end cap |

#### Housing

##### HOUSING

- |        |   |
|--------|---|
| RD200C | • RD200C - Technopolymer installation housing |
|--------|---|



## RDD200

### OPTIONAL ACCESSORIES

#### Jumper Cables - art. JCUTL4PC

##### LENGTHS

- |    |                       |
|----|-----------------------|
| 1  | • 1 - 1m feed cable   |
| 3  | • 3 - 3m feed cable   |
| 6  | • 6 - 6m feed cable   |
| 9  | • 9 - 9m feed cable   |
| 20 | • 20 - 20m feed cable |

#### Splitters - art. SUTL4P2W

##### SPLITTERS

- |    |                             |
|----|-----------------------------|
| P  | • P - Data splitter         |
| D  | • D - Power & Data splitter |
| PD | • PD - Power splitter       |

#### Various Accessories

##### VARIOUS

- |        |                         |
|--------|-------------------------|
| 104853 | • 104853 - Removal Tool |
|--------|-------------------------|



## RDD200

### INSTALLATION DETAILS

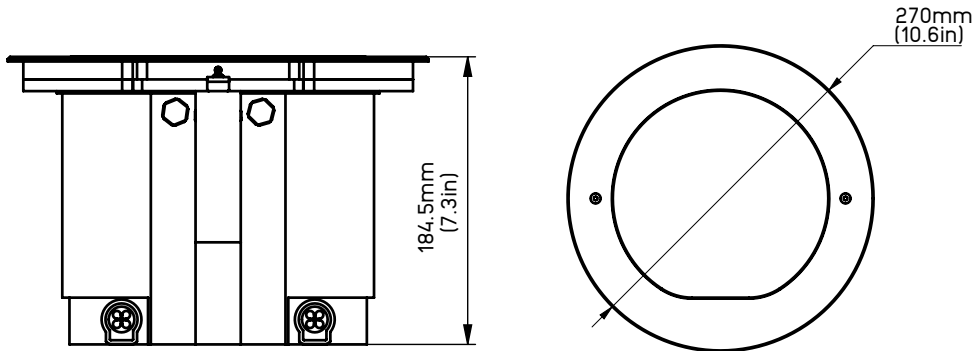

The standard luminaires are equipped with connectors, facilitating seamless line connections with feed or jumper connectors. In scenarios necessitating on-site adjustment of the LED module, an accessible IP-secured height adjustment is provided to improve glare control and ensure precise light beam performance.

#### LED module height adjustment

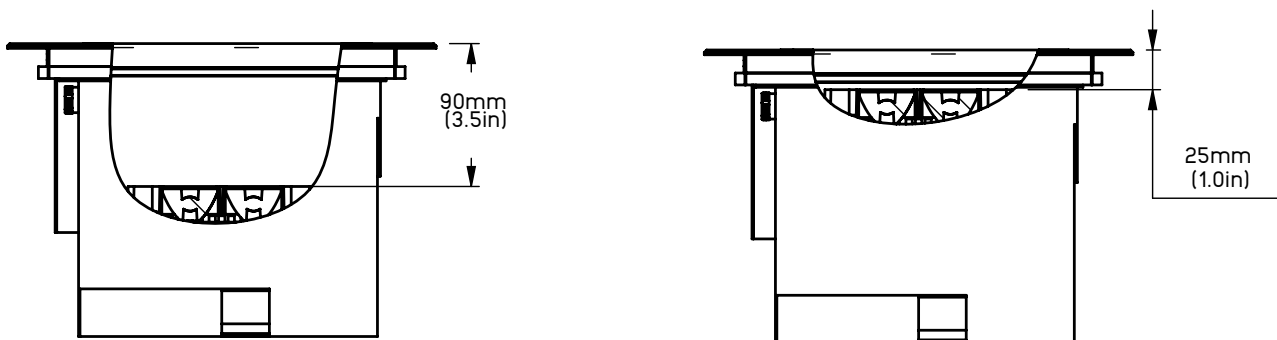

LED module height adjustment feature enables convenient on-site adjustments to be made without necessitating the removal of the glass cover. This not only ensures ease of maintenance but also preserves the integrity of the optical components, contributing to the overall efficiency and reliability of the system. Used to adjust the position of the LED module for better glare control in various applications. Positioning the LED module deeper in the body provides better glare control in areas with high traffic. A more shallow position offers higher lumen output but reduces glare control.

RDD200 is flood-proof, capable of withstanding full submersion for up to 24 hours

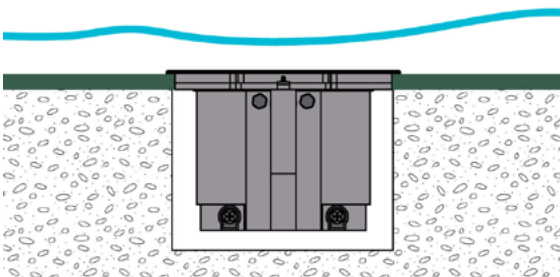



## RDD200

### GLARE CONTROL

#### Internal glare control:

##### Microlouvre

Provides low glare control with 30% less lumen output than product without louvres. best for use where pedestrians are at least 6m from the light source

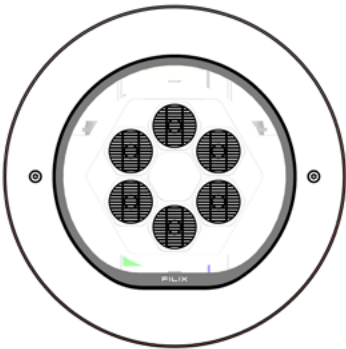

##### Hex louvre

Provides low glare control with 45% less lumen output than product without louvres. best for use in moderate traffic where pedestrians are at least 3m from the light source

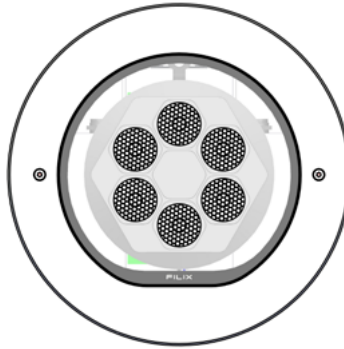

##### Discrete sight

Provides low glare control with 60% less lumen output than product without louvres. best for use in high traffic areas where pedestrians are at least 0,5m away from the source



### GLASS TYPE

##### Clear glass

Provides maximum opening for the light beam output. Used in areas where maximum fixture output is needed.



##### Half Moon

Provides glare control by reducing lumen output and implementing a light beam cutoff, resulting in a 50% reduction in stray light and minimized light dispersion in undesirable directions.

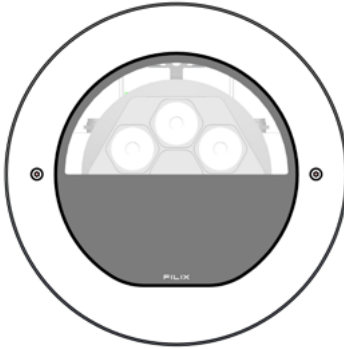

##### Anti Slip Glass

Designed and manufactured to reduce the risk of slipping and falling by providing a textured surface that enhances traction, even when wet.

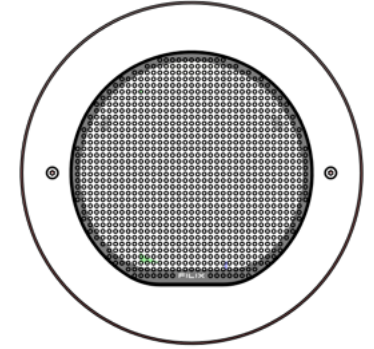



## RDD200

### MANDATORY ACCESSORIES

#### Feed cable

Length options 1m, 3m, 6m, 9m  
The rugged rubber cables are versatile, with open wires for mains connection and a snap-in connector for fixture connection. They're rated IP68/IP69K and resistant to UV exposure, ideal for marine use. Note that feed cables are mandatory to order.

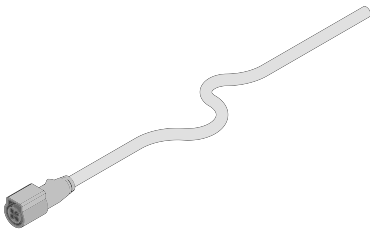

#### End cap

Endcap for receptacle, providing IP67 protection when securely locked. Required for all runs' terminations, excluding those under DMX (Data Pulse) control.

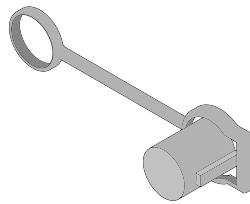

#### Terminator

DMX terminator cap for receptacle provides IP68/IP69K protection when securely locked. Required for all runs' under DMX (Data Pulse) control.

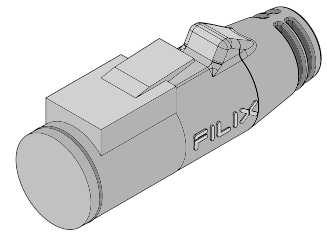

#### Installation Housing

Used to install single or multiple fixtures. Made out of extruded technopolymer with multiple cable entries and endcaps on both ends to mitigate any possibility of concrete entry. Versatile housing offers installation near the walls while allowing "stashing" multiple meters of cable in the plastic compartment. The housing offers the leveling option when installing on rough terrains. Drainage knock out hole available.

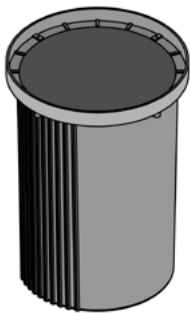





## RDD200

### OPTIONAL ACCESSORIES

#### Jumper cable

Length options 1m, 3m, 6m, 9m  
Jumper cables, a necessity for non-end-to-end configurations, feature connectors on both ends for easy connection. Constructed with robust rubber material, they endure mechanical stress and harsh environments. Rated IP68/IP69K and resistant to UV exposure, they are ideal for marine applications.

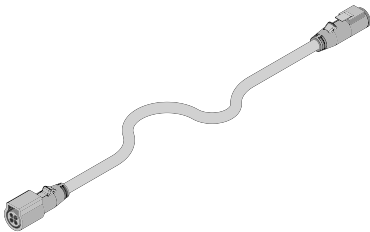

#### Removal tool

Equipped with a specialized suction mechanism, it securely adheres to glass surfaces, ensuring safe and precise lifting and handling operations. This tool is essential for various applications where a reliable and controlled grip is paramount, promoting efficiency and workplace safety.

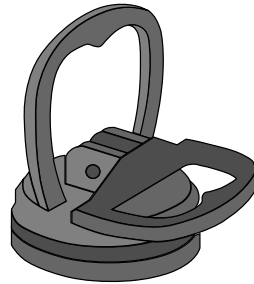

#### Data Splitter

A Data Splitter serves in DMX (Data Pulse) applications when there's untapped capacity on the fuse for additional fixtures. This device efficiently utilizes available resources by allowing one fuse to serve two separate DMX universes. By simplifying cabling and streamlining data flow, it optimizes lighting setup, making it more efficient and cost-effective.

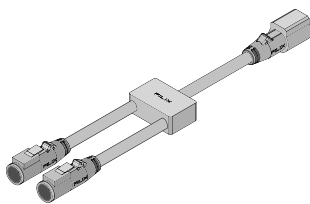

#### Power & Data Splitter

A Power & Data Splitter plays a crucial role in DALI, and 1-10V applications, especially when there's a requirement to establish "tree" or "star" connection topologies. This versatile splitter excels at efficiently distributing both power and data, enabling seamless branching out of your lighting system.

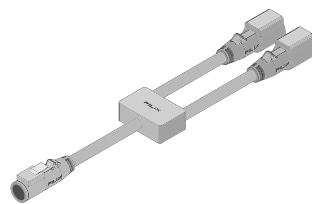

#### Power Splitter

A Power Splitter is crucial for handling ON/OFF applications, particularly when there's a requirement for branching connections in "tree" or "star" topologies. This splitter facilitates the effective distribution of power, guaranteeing a smooth expansion of your lighting network.

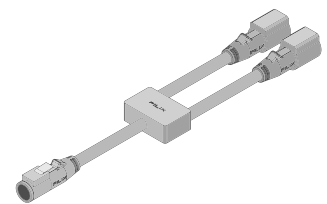



# RDD200

## OPTICS

**Narrow Spot**  
Angle: 8°x8°  
Delivered lumen: 2625lm

**Medium Spot**  
Angle: 15°x15°  
Delivered lumen: 2550lm

**Narrow Flood**  
Angle: 30°x30°  
Delivered lumen: 2400lm

**Medium Flood**  
Angle: 40°x40°  
Delivered lumen: 2325lm

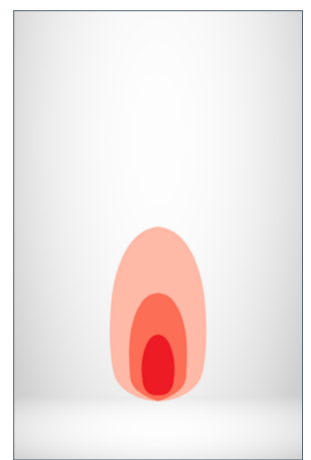
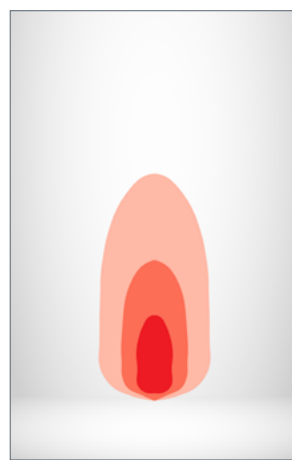
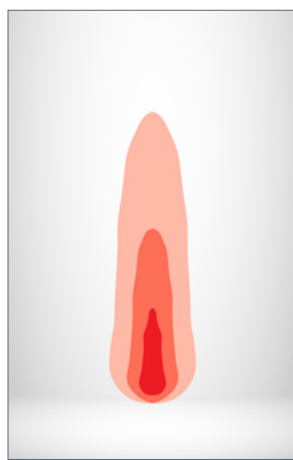
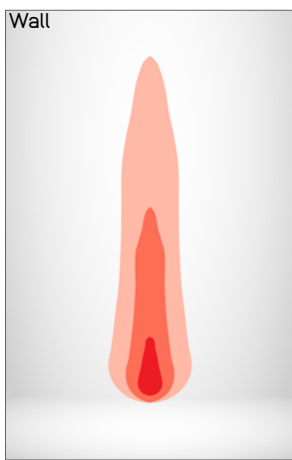
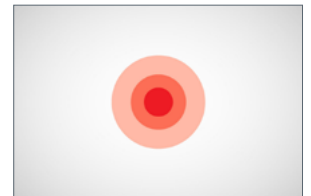
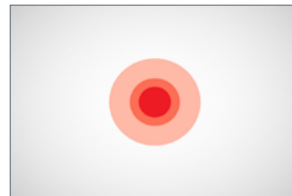
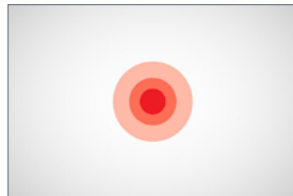
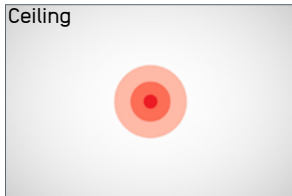

**Wide**  
Angle: 60°x60°  
Delivered lumen: 2175lm

**Spot Asymmetric**  
Angle: 10°x20°  
Delivered lumen: 2550lm

**Narrow Asymmetric**  
Angle: 10°x40°  
Delivered lumen: 2450lm

**Medium Asymmetric**  
Angle: 10°x60°  
Delivered lumen: 2300lm

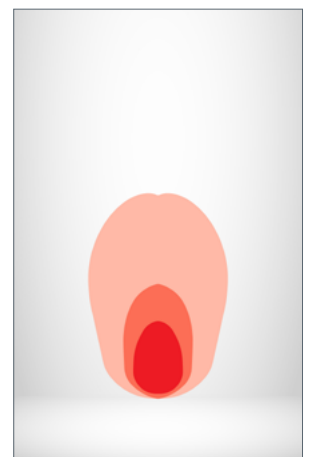
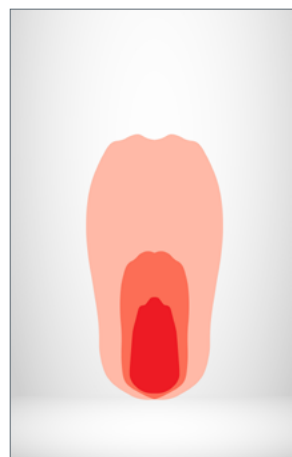
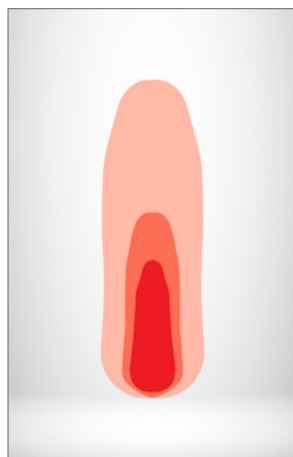
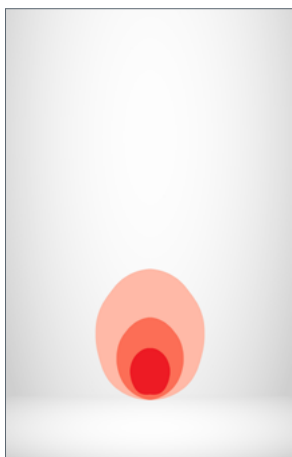
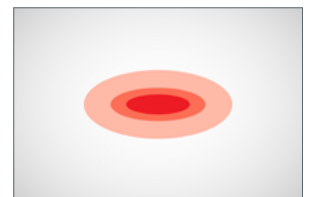
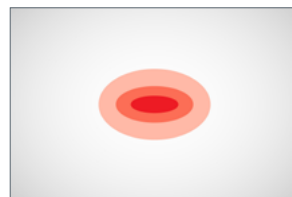
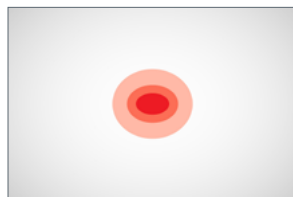
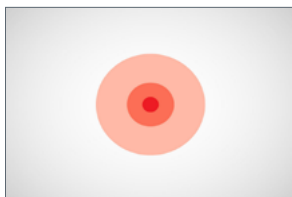

### Notes

- Depending on the beam angle and power of the fixture, it has the capability to project light up to 100m (330ft)
- Light output values based on 25W and 3000K product



## Control

### ON/OFF SYSTEM TOPOLOGY

#### Integrated systems:

- X Line
- Heat Sense
- Split & Seal

#### System components

- Wiring, protective devices and junction boxes leading up to feed cable at the start of the line are the responsibility of others
- Feed cables and necessary accessories that are marked as mandatory must be ordered separately
- For optional branching of the system Power Splitter must be used
- Advised protective components:
  - Surge protector device
  - Inrush current limiter

#### System topology

- In the system design, any of the following system topologies can be utilized: line wiring, star wiring, or tree wiring.

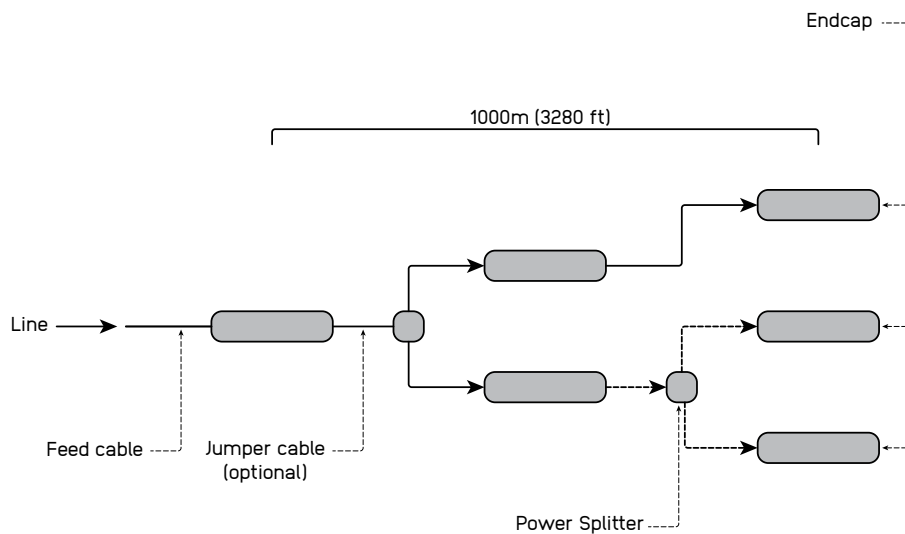

#### Addressing & dimming notes

- ON/OFF system does not allow device addressing
- Dimming of the product not available in this system

#### Segment length and limitations

- The minimum segment length is equal to one product
- The maximum distance between the first and last fitting is limited to maximum voltage drop and fuse rating.
- Used only in single colour applications

#### Fault tolerance

- If one product fails the rest of the system continues to work
- Class I wiring implemented in the fixture and voltage fluctuation filter implemented



## Control

### 0-10V SYSTEM TOPOLOGY

#### Integrated systems:

- X Line
- Heat Sense
- Split & Seal

#### System components

- The 0-10V system, wiring, protective devices and junction boxes leading up to feed cable at the start of the line are the responsibility of others
- Feed cables and necessary accessories that are marked as mandatory must be ordered separately
- For optional branching of the system Power & Data Splitter must be used
- Advised protective components:
  - Surge protector device
  - Inrush current limiter

#### System topology

- In the system design, any of the following system topologies can be utilized: line wiring, star wiring, or tree wiring.

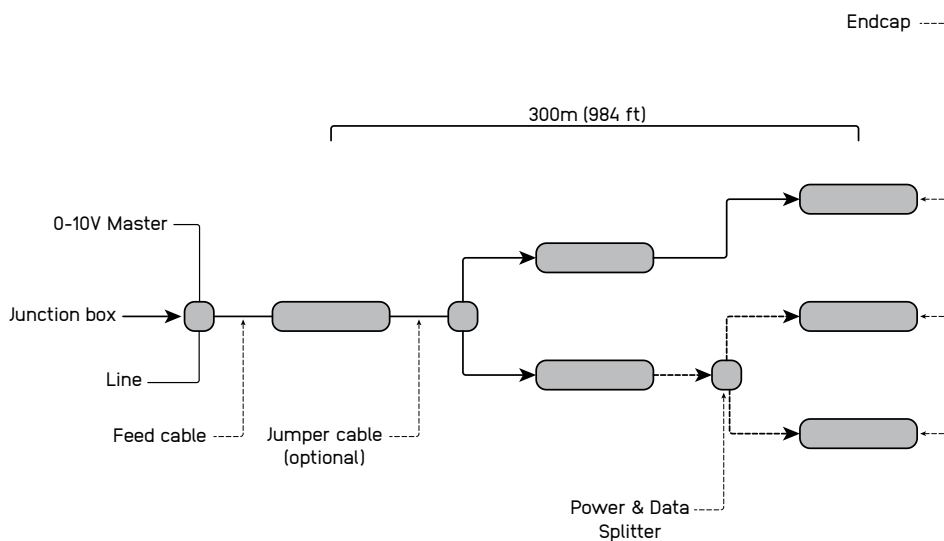

#### Addressing & dimming notes

- 0-10V protocol does not allow addressing devices individually
- The product is initially equipped with linear dimming settings and it is suggested for the controllers to be logarithmic in order to get the dimming that is most preferred in most cases due to the dimming curve perceived by human eye
- 0%-100% dimming range
- The product is initially set up as a source instead of as a sink type
- The product could also be set up as a sink type but this should be noted to sales representative

#### Segment length and limitations

- The minimum segment length is equal to one product
- The maximum distance between two fittings is 30 meters, and the maximum distance between the first and last fitting is 300 meters.
- Used in single colour applications

#### Fault tolerance

- If the product is source type and in the case the control line doesn't have power the light fitting will turn at 100%. in the opposite case where the light is sink type, light will not work.
- If one product fails the rest of the system continues to work
- Class I wiring implemented in the fixture and voltage fluctuation filter implemented



## Control

### DALI SYSTEM TOPOLOGY

#### Integrated systems:

- X Line
- Heat Sense
- Split & Seal

#### System components

- The DALI system, wiring, protective devices and junction boxes leading up to feed cable at the start of the line are the responsibility of others
- Feed cables and necessary accessories that are marked as mandatory must be ordered separately
- For optional branching of the system Power & Data Splitter must be used
- Advised protective components:
  - Surge protector device
  - Inrush current limiter

#### System topology

- In the system design, any of the following system topologies can be utilized: line wiring, star wiring, or tree wiring.

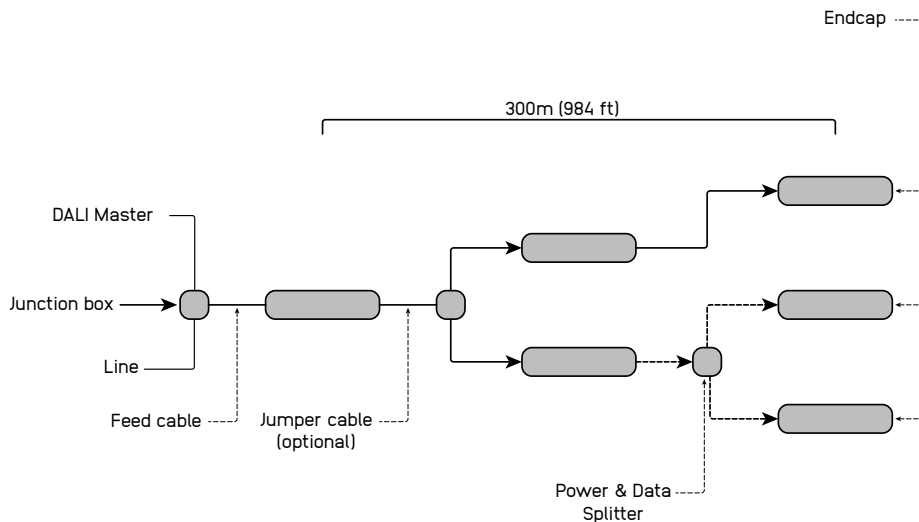

#### Addressing & dimming notes

- DALI protocol allows addressing devices individually
- Addressing methods include a short address for individual devices, group addresses for up to 16 groups, and a broadcast address that targets everything on the line.
- Logarithmic and linear dimming options available. the product is initially equipped with logarithmic dimming settings, while you can easily switch to logarithmic dimming using a configuration device.
- 0,4%-100% dimming range

#### Segment length and limitations

- The minimum segment length is equal to one product
- A DALI master has the capacity to manage a line containing a maximum of 64 devices. Each device can be allocated to 16 unique groups and 16 individual scenes.
- The maximum distance between two fittings is 30 meters, and the maximum distance between the first and last fitting is 300 meters.
- Used in single colour and tunable white applications

#### Fault tolerance

- Due to its relatively slow operating speed and high bus voltage, the DALI system exhibits significant reliability in the presence of electrical interference, making shielding unnecessary
- If one product fails the rest of the system continues to work



## Control

### DMX SYSTEM TOPOLOGY

#### Integrated systems:

- Data Pulse: One unit for both power management and data control when utilizing the DMX protocol.
- Data Whisper
- X Line
- Colour Shout
- Heat Sense
- Split & Seal

#### System components

- The DMX system, wiring, protective devices and junction boxes leading up to Data Pulse at the start of the line are the responsibility of others
- Feed cables and necessary accessories are mandatory and must to be ordered separately
- For optional DMX address addition in the line, a data splitter must be used.
- Advised protective components:
  - Surge protector device
  - Inrush current limiter

#### System topology

- In the system design, line wiring can only be used

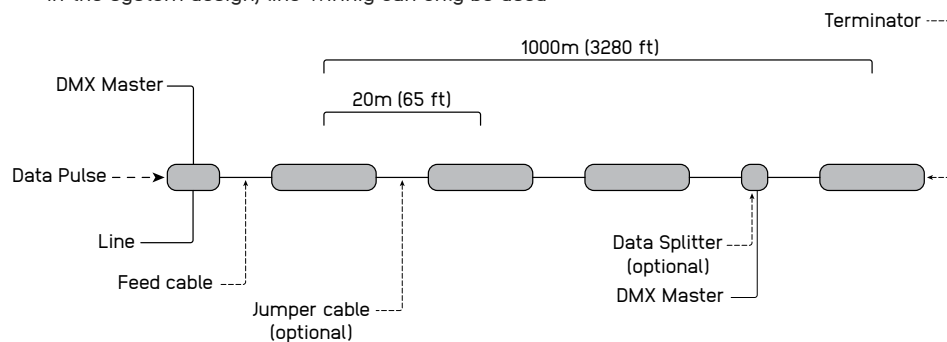

#### Addressing & dimming notes

- DMX protocol allows addressing devices individually
- Addressing methods allow short address for individual devices
- Logarithmic and linear dimming options available. the product is initially equipped with logarithmic dimming settings, while you can easily switch to logarithmic dimming using a configuration device.
- 0%-100% dimming range

#### Segment length and limitations

- The minimum segment length is equal to one product.
- A DMX universe has the capacity to manage a line containing a maximum of 512 addresses. Each Luminaire can be allocated to maximum 4 unique addresses.
- The maximum distance between two fittings is 30m (98ft), and the maximum distance between the first and last fitting is 1000 meters.
- Used in single colour, tunable white, and RGBW applications
- DMX addresses can be programmed in factory or on site. Consult your sales representative if addressing is to be done in factory

#### Fault tolerance

- Due to Data Pulse technology, the DMX system exhibits significant reliability in the presence of electrical interference, making shielding unnecessary
- If one product fails the rest of the system continues to work