

# ARPOOL LINEAR RECESSED 360/660

## INSTALLATION INSTRUCTIONS (HOUSING)

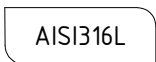
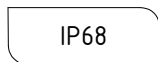
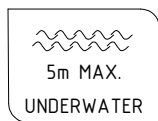
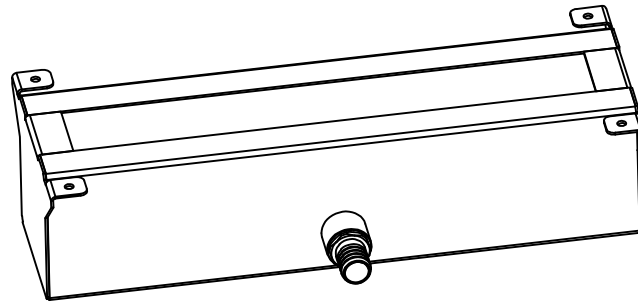

ALL DIMENSIONS ARE GIVEN ACCORDING TO THE SI SYSTEM OF UNITS (MM, KG, °C), ADDITIONAL DIMENSIONS THAT ARE WRITTEN IN BRACKETS, ARE GIVEN ACCORDING TO THE U.S. MEASUREMENT SYSTEM (IN, LBS, °F)

### GENERAL REMARKS ON SAFETY

- READ ALL OF THESE INSTRUCTIONS BEFORE INSTALLING THE HOUSING.
- KEEP ALL OF THE INSTRUCTIONS FOR FUTURE REFERENCE.
- INSTALLATION IS TO BE PERFORMED BY A QUALIFIED CONTRACTOR.
- ALL INSTALLATIONS ARE TO CONFORM TO THE STANDARDS OF THE NATIONAL ELECTRICAL CODE AS WELL AS ALL LOCAL JURISDICTIONAL CODES AND REGULATIONS.
- THE MANUFACTURER ACCEPTS NO RESPONSIBILITY FOR DAMAGE TO PERSONS OR PROPERTY ARISING THROUGH IMPROPER USE OR INSTALLATION.
- HOUSINGS' SURFACES EXPOSED TO THE EFFECTS OF WATER (INCLUDING WATER CONTAINING CHLORINE) ARE MADE OUT OF AISI316L STAINLESS STEEL. AISI316L IS SUITABLE FOR THIS USE AND WILL PREVENT CORROSION UP TO LEVEL OF 1000 PPM OF CHLORINE IN WATER AND UP TO WATER pH LEVEL OF 7.

### WARRANTY

ALL PRODUCTS ARE FACTORY TESTED AND ARE GUARANTEED FREE FROM FACTORY DEFECT FOR A PERIOD OF 36 MONTHS UNDER FOLLOWING TERMS:

- PRODUCT HAS NOT BEEN SUBJECT TO INCORRECT VOLTAGE OR POLARITY CONNECTION.
- PRODUCT HAS NOT BEEN SUBJECT TO PHYSICAL OR ATMOSPHERIC DAMAGE.
- PRODUCT HAS BEEN RETURNED AND FACTORY EVALUATED FOR DEFECT OR MALFUNCTION.
- ALL DRIVERS AND CONTROLLERS ARE APPROVED FOR USE BY FILIX.
- THE HOUSING FACTORY SEAL ( IP RATING ) HAS NOT BEEN COMPROMISED

THE MANUFACTURER ACCEPTS NO RESPONSIBILITY FOR DAMAGE TO PERSONS OR PROPERTY ARISING THROUGH IMPROPER USE OR INSTALLATION.

ANY MODIFICATION OF THE HOUSING WILL VOID ANY AND ALL WRITTEN OR IMPLIED WARRANTIES.

### STANDARD REPLACEMENT AND NORMAL SERVICING TERMS.

ALL ELECTRONIC AND OTHER CONSUMABLE COMPONENTS ARE SUBJECT OF EXCHANGE AFTER 36 MONTHS OF OPERATIONS. PRODUCT PERFORMANCE DEPENDS OF CRITICAL ELECTRONIC AND OTHER COMPONENTS WHICH CAN BE SERVICED WITH OFFICIAL DEALER OR DIRECTLY WITH THE MANUFACTURER.

MANUFACTURER HOLDS THE RIGHT TO REPAIR AND CHANGE COMPONENTS AS PER CURRENT COMPONENT AVAILABILITY.

MANUFACTURER CANNOT BE HELD LIABLE FOR COMPONENTS AND OTHER EXPENSES ( DE-INSTALLATION, INSTALLATION, SHIPPING, ETC.) INCURRED DURING THE PROCESS OF PRODUCT IMPROVEMENT AND SERVICING.

# HOUSING DIMENSIONS

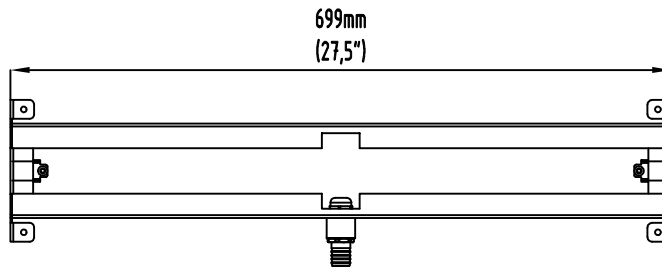
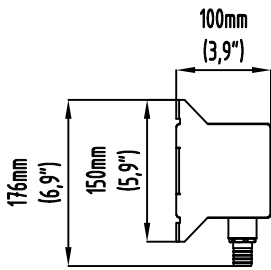
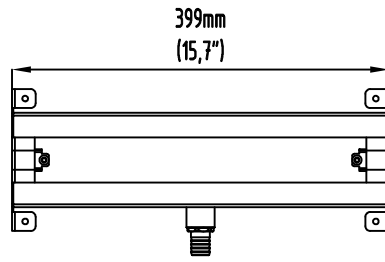
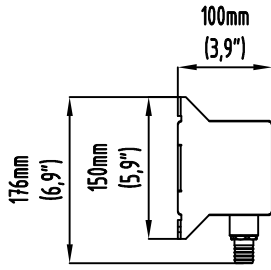

## INSTALLATION GUIDE

1. MOUNT THE HOUSING ON THE FORMWORK WITH THE NAILS(A4).
2. FIX THE CABLE CONDUIT HOSE WITH THE CABLE CLAMP TO THE CABLE GLAND
3. CONNECT GROUNDING TO THE HOUSING
4. POUR THE CONCRETE AROUND THE HOUSING
5. CUT OF THE EXCESS NAIL
6. REMOVE THE FORMWORK AND PUT TILES

**FILIX**  
www.filixlighting.com

